

- Easy open/close-mechanism
- Condensation protected
- Adjustable distribution pattern
- Several filter-alternatives
- Complete range of accessories

## Fresh 100

Wall vent designed to provide a continuous airflow into the building/house. The vent is supplied with filter and condensation protection. Fresh 100 is also available in a sound-reduced model (Fresh 100dB).

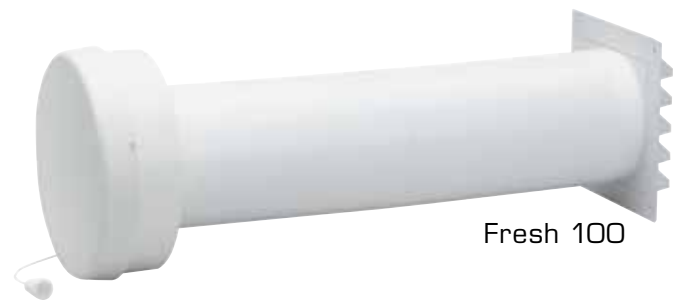

Fresh 100



Fresh 100-dB

## Specification

Product	Description	Art. no.
Fresh 100 Individually packed	Complete vent with wall pipe Ø95/99 mm	189001
Fresh 100 Individually packed	Complete vent with wall pipe Ø98/102 mm	189002
Fresh 100 Bulk	Complete vent with wall pipe Ø95/99 mm	870001
Fresh 100 Bulk	Complete vent with wall pipe Ø98/102 mm	870005
Fresh 100 Internal part	Internal part	870011
Fresh 100-dB Bulk	Complete sound-reduced vent, wall pipe Ø98/148 x 400 mm	875121

The vent can easily be adjusted to suit special requests (larger cover plates, other dB-pipe-lengths etc).

## Technical facts

Capacity:	9,0 l/s at 10 Pa
Wall opening:	Ø102, Ø105 (standard vent) or Ø150 mm (sound-reduced vent)
Material:	ABS-plastic (recyclable)
Colour:	White, RAL 9010

# FRESH 100

Air supply vent

## Description/function

### Standard vent

Air supply vent for wall mounting. The vent is capable of providing the room with large quantities of fresh air without causing draughts. A complete set contain internal part, wall pipes and external grille. The wall pipes are available in two dimensions, Ø99 or Ø102mm. The pipes fit telescopically which provides a flexible join.

### Internal part

The internal part is provided with a standard filter and condensation protection. The vent can easily be open/closed with the pull cord. Minimum-flow can be set by adjusting the setting screw (see illustration below). The distribution pattern can be adjusted by using an air deflector (accessory). The vent has three filter alternatives; Standard filter (dust & insect filter), Pollen filter (EU3) and Environmental filter (EU7).

### Sound-reduced vent

The sound-reduced model has another wall pipe than the standard. Besides the dB-pipe the vent also contain two cover plates. The pipe length is 400mm as standard but can easily be cut to requested length (max.1200mm).

### Mounting

A high placing is recommended preferably above a radiator. With this solution the incoming air mixes with the convection flow of warm air, ensuring maximum comfort. When using the vent in rooms with under-floor-heating please complement with an air deflector (ensures a better mix of air and prevents draught, accessory).

### Minimumflow setting

The minimumflow is set by taking off the front cover (from shut position). Insert a small screwdriver into the rim and pull the cover outwards. The vent opening is infinitely variable by adjusting the setting screw.

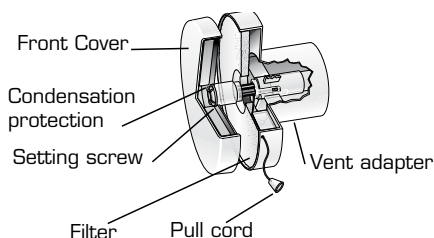

Fresh 100, Ø99mm		
Pos.	Description	Art no
1	Fresh 100 Internal part	870011
2	Wall pipe Ø95/99 x 150 mm	830150
3	External grille #140	831401

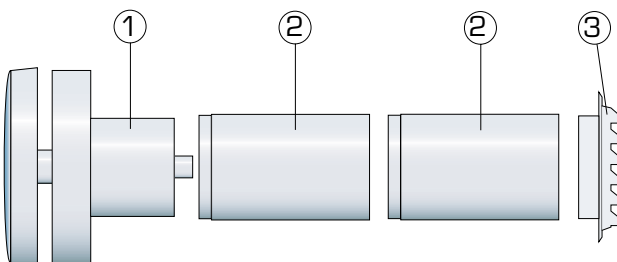

Fresh 100, Ø102mm		
Pos.	Description	Art no
1	Fresh 100 Internal part incl rubber seal (art no 008247)	870011
2	Wall pipe, 102x50mm	661050
3	Wall pipe, 98/102x100mm	188009
4	Adapter 10, 102x60mm	661063
5	External grille #150	801701

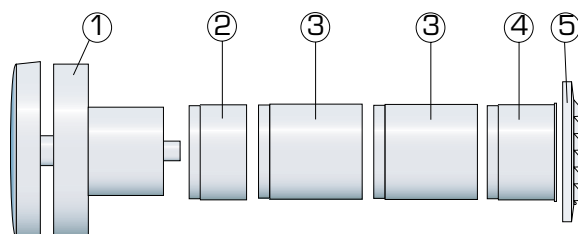

Fresh 100-dB, Ø 140mm		
Pos.	Description	Art no
1	Fresh 100 Internal part incl cover plate #210	875101
2	dB-pipe Ø98/140 x 400mm	855004
3	External dB-grille incl cover plate #165	861651

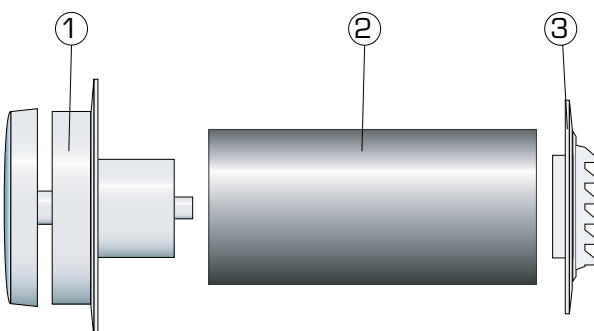

Technical data Fresh 100	
Capacity at 10 Pa:	9,0 l/s
Wall opening:	Ø105 mm
Max wallthickness:	350 mm. Additional wall pipes are available (accessory).
Material:	ABS-plastic (recyclable)
Colour:	White, RAL 9010
Sound reduction $D_{n,e,w}$ :	33 dB
Technical data Fresh 100-dB	
Wall opening:	Ø150 mm
Max wall thickness:	400 mm. For other lengths please contact Fresh AB.

## Capacity

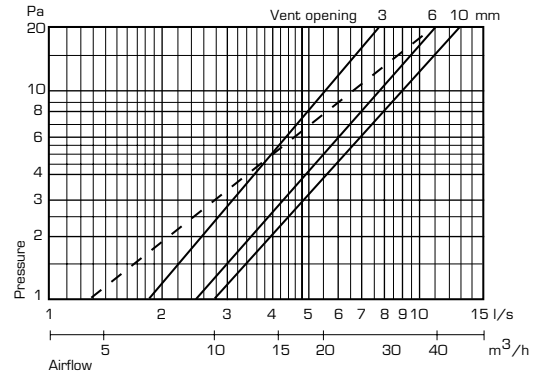

The dotted line illustrates pollen/environmental filter at 10 mm opening.

## Dimensions Fresh 100, Ø99mm

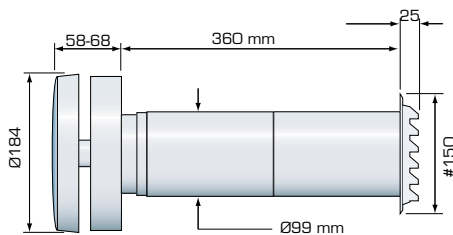

## Dimensions Fresh 100, Ø102mm

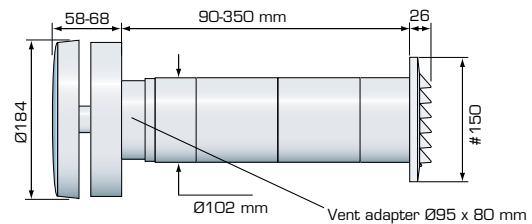

## Dimensions Fresh 100-dB, Ø140mm

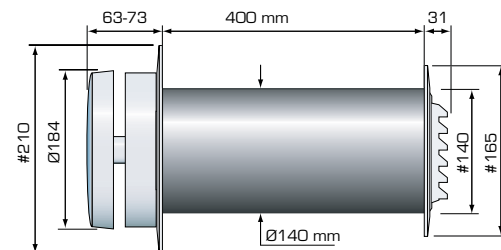

## Sound data

The diagrams below show sound reduction with fully open vent. The calculations are based on a reference area of 10 m<sup>2</sup>.

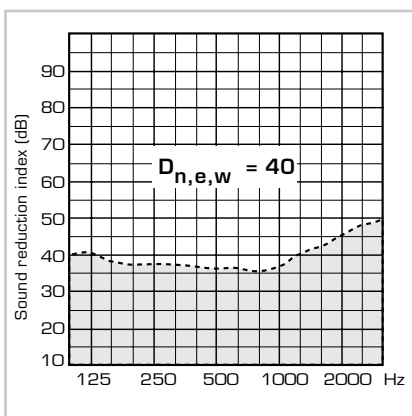

Fresh 100-dB with 200 mm wall pipe.

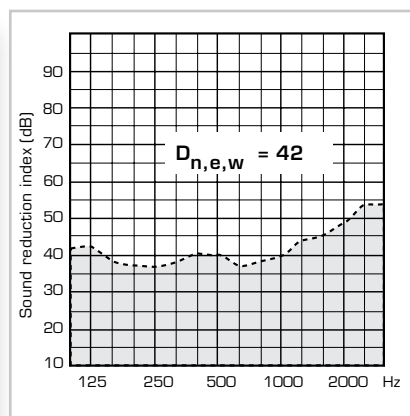

Fresh 100-dB with 300 mm wall pipe.

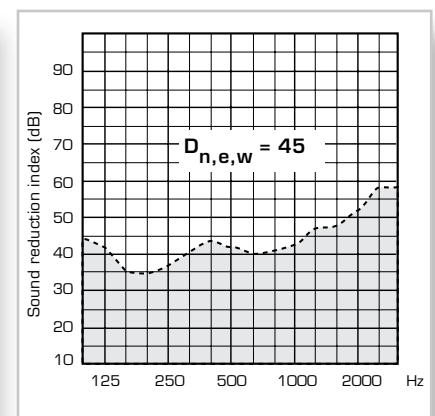

Fresh 100-dB with 400 mm wall pipe.

# FRESH 100

Air supply vent

## Distribution pattern

The diagrams show that Fresh 100 can handle up to 8 l/s at -20°C without any draught problem. The white areas show the distribution pattern for air movements above 0.15 m/s.

The shaded part is the area outside the living/working-space.

## Maintenance

In order to ensure correct airflow and to retain good air quality it is important to keep the filter clean. We recommend to wash/replace the filter 1-2/year.

The Standard filter is washable (use a gentle soap/detergent). The Pollen filter and Environmental filter should be replaced with a new filter.

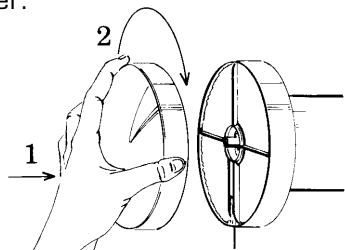

To get access to the filter press the cover and turn it clockwise. Pull off the cover and remove the filter holder. The filter is now accessible to be washed/replaced.

## Accessories



**Wall pipe**  
Available in different lengths and sizes



**Cover plate**  
Available in different sizes and colours



**Storm shield**  
Ø95 mm, regulates air supply during heavy winds



**Storm shield**  
Ø98 mm, regulates air supply during heavy winds



**Air director**  
Regulates the air direction



**Filters**  
Pollen filter (EU3) and Environmental filter (EU7)

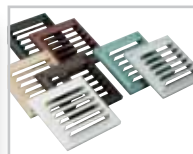

**External grille**  
Available in different sizes and colours



**Rain-shield**

