

- Unique distribution pattern
- Condensation protected
- Minimum flow-setting
- Several filter alternatives
- Complete range of accessories



Fresh 90

Square-shaped wall vent designed to provide a continuous airflow into the building/house. The vent is supplied with filter and condensation protection. The vent is also available in a sound-reduced model (Fresh 90dB).



Specification		
Product	Description	Art no
Fresh 90 Individually packed	Complete vent with wall pipe Ø95/99 mm	190001
Fresh 90 Individually packed	Complete vent with wall pipe Ø98/102 mm	190002
Fresh 90 Bulk	Complete vent with wall pipe Ø95/99 mm	900001
Fresh 90 Bulk	Complete vent with wall pipe Ø98/102 mm	900005
Fresh 90 Internal part	Internal part	900011
Fresh 90-dB Bulk	Complete soundreduced vent, wall pipe Ø98/140 x 400 mm	905121

The vent can easily be adjusted to suit special requests (larger cover plates, other pipe-lengths etc).

Technical Facts	
Capacity:	9,0 l/s at 10 Pa
Wall opening:	Ø102, Ø105 mm (standard vents) or Ø150 mm (sound-reduced vent)
Material:	ABS-plastic (recyclable)
Colour:	White, RAL 9010

FRESH 90

Air supply vent

Description/function

Standard vent

Square-shaped wall vent designed to provide a continuous airflow into the building/house. The vent is supplied with filter and condensation protection. The vent is capable of providing the room with large quantities of fresh air without causing draught.

A complete set contain internal part, wall pipes and external grille #150.

The wall pipes are available in two dimensions, Ø99mm and Ø102mm. The pipes fit telescopically which provides a flexible join.

Internal part

Fresh 90 has a unique distribution pattern. The vent is airtight underneath the front cover while the top part allows much more airflow than the sides. This unique construction reduces the risk of draughts considerably.

The internal part contain condensation protection and an easily removed Standard filter. Pollen filter (EU3) and Environmental filter (EU7) are available as accessories.

The airflow is adjusted by the built-in regulator underneath the vent.

The damper plate has pre-pressed punch-outs so that different minimum flow-levels can be achieved.

Sound-reduced vent

The soundreduced vent has another wall pipe than the standard vent. Besides the dB-pipe the vent also contain two cover plates (#165). The pipe length is 400mm as standard but can easily be cut to requested length (max 1200mm).

Mounting

A high placing is recommended, preferably above a radiator. With this solution the incoming air get mixed with the convection flow of warm air ensuring maximum comfort. Fresh 90 can with advantage be used in rooms with underfloor-heating due to the unique construction of the air openings.

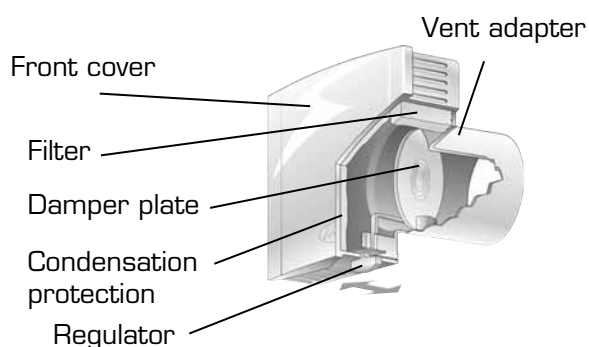

Fresh 90, Ø99mm		
Pos.	Description	Art no
1	Fresh 90 Internal part	900011
2	Wall pipe Ø99 x 150 mm	830150
3	External grille #140 mm	831401

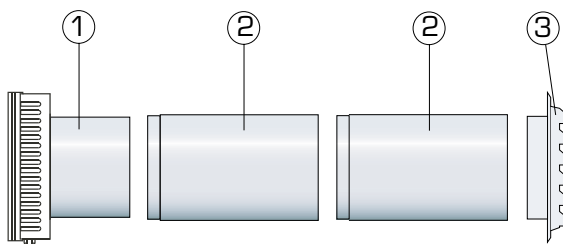

Fresh 90, Ø102mm		
Pos.	Description	Art no
1	Fresh 90 Internal part incl rubber seal (art no 008247)	900011
2	Wall pipe, 102x50mm	661050
3	Wall pipe, 98/102x100mm	188009
4	Adapter 10, 102x60mm	661063
5	External grille #150	801701

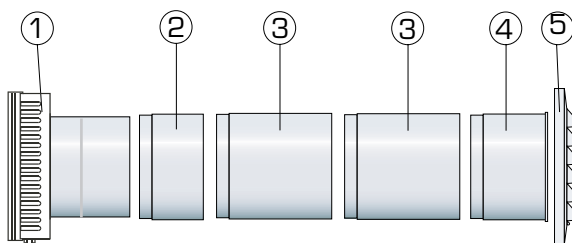

Fresh 90-dB, Ø140mm		
Pos.	Description	Art no
1	Fresh 90 Internal part incl cover plate #165	905101
2	dB-pipe Ø98/140 x 400 mm	855004
3	External dB-grille incl. cover-plate #165	861651

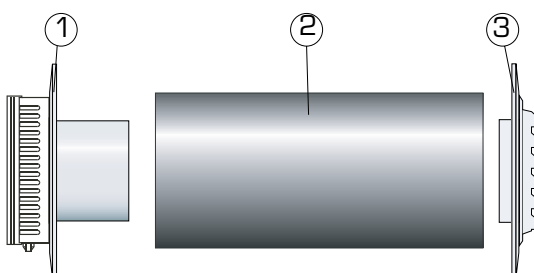

Technical data Fresh 90	
Capacity at 10 Pa:	9,0 l/s
Wall opening:	Ø102 mm (99-dim) Ø105 mm (102-dim)
Max wall thickness:	360 mm (99-dim) 350 mm (102-dim) Additional wall pipes are available for thicker walls.
Material:	ABS-plastic (recyclable)
Colour:	White, RAL 9010
Technical data Fresh 90-dB	
Wall opening:	Ø150 mm
Max wall thickness:	400 mm. For other lengths please contact Fresh AB.

Capacity

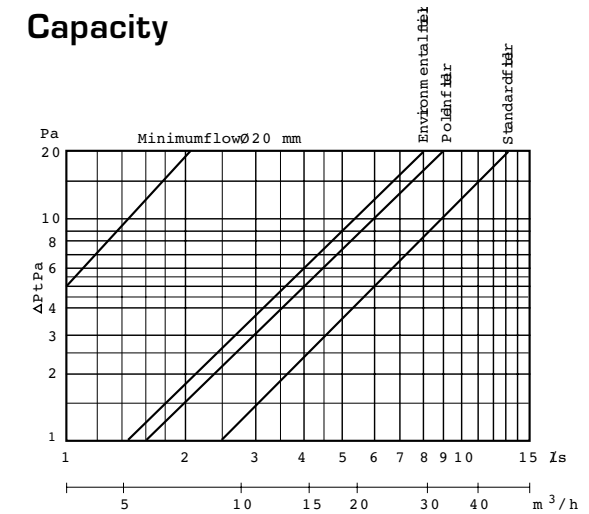

The lines for the filter alternatives illustrate fully open vent.

Dimensions Fresh 90, Ø99mm

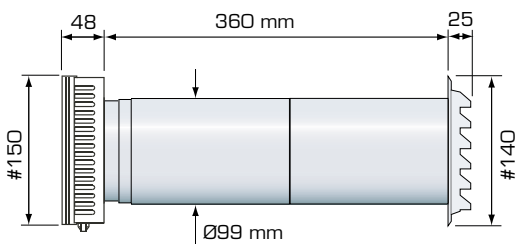

Dimensions Fresh 90, Ø102mm

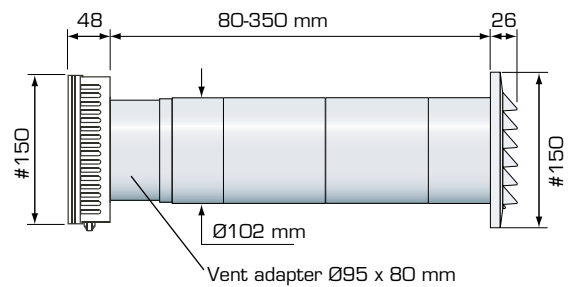

Dimensions Fresh 90-dB, Ø140mm

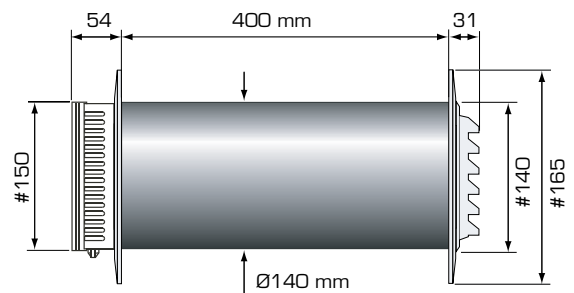

Sound data

The diagrams show sound reduction with fully open vent. The calculations are based on a reference area of 10 m².

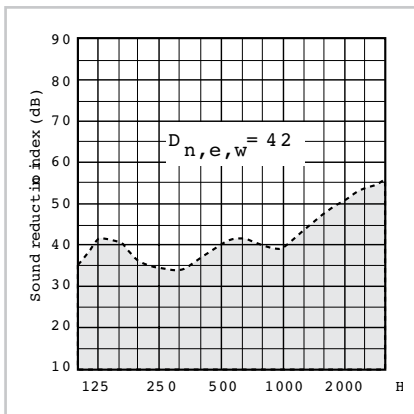

Fresh 90-dB with 200mm wall pipe.

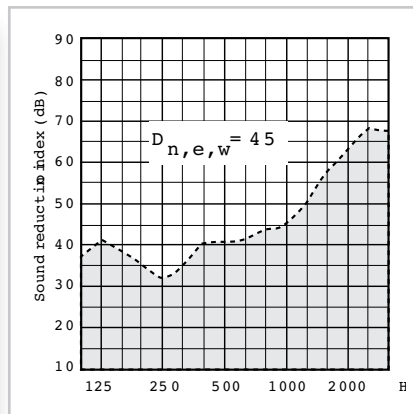

Fresh 90-dB with 300mm wall pipe.

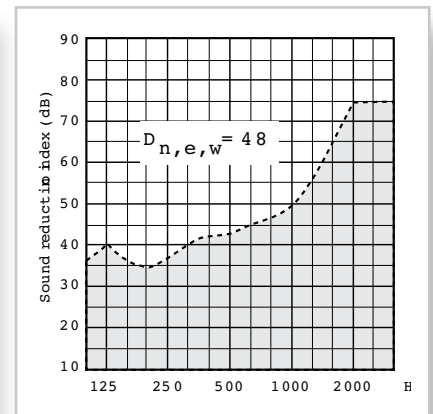

Fresh 90-dB with 400mm wall pipe.

FRESH 90

Air supply vent

Distribution pattern

The diagrams show that Fresh 90 can handle up to 8 l/s at -20°C without causing draught problems. The white areas show the distribution pattern for air movements above 0.15 m/s. The shaded part is the area outside the living/working-space.

Maintenance

In order to ensure correct air flow and to retain good air quality it is important to keep the filter clean. We recommend to wash/replace the filter 1-2/year.

The Standard filter is washable (use a gentle soap/detergent). The Pollen filter and Environmental filter should be replaced with a new one. The filter is mounted in the front cover which is easily dismantled.

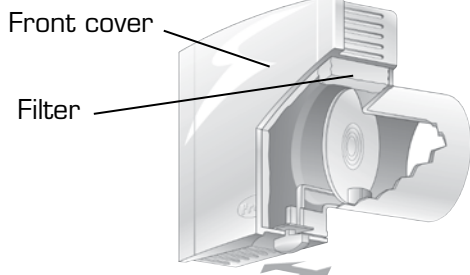

Accessories



Wall pipe
Available in different lengths and sizes



Cover plate
Available in different sizes and colours



Storm shield
 $\text{Ø}95\text{ mm}$, regulates air supply during heavy winds

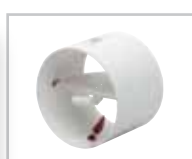

Storm shield
 $\text{Ø}98\text{ mm}$, regulates air supply during heavy winds



Filters
Pollen (EU3) and Environmental (EU7)

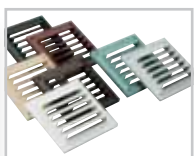

External grille
Available in different sizes and colours



Rain-shield

