



SI system

The SI international system of units of measurements is used throughout this catalogue.

Key to terms

- q = gas-flow, m³/s
- Pt = total increase in pressure, Pa
- n = rotation speed of fan, rpm
- Pe = power requirements according to graph W
- L = operating curve
- Material 0 = PVC (polyvinyl chloride)
- Material 1 = GRP (glassfibre-reinforced polyester)
- Material 2 = PP (polypropylene)
- Material 3 = Various materials
- Material 4 = PPS-EL (copolymer propylene, anti-static and self-extinguishing)

Symbols

- T  T impeller, true radial blades
- B  B impeller, rearward-curved blades
- P  P impeller, true rearward-angled blades

Balanced fans

All fans manufactured by Arex are dynamically balanced. This is of particular importance, especially as the rotation speed of the fans is high and some of the fans are quite large.

AREX fans are dynamically balanced by machine on two parallel balancing planes, in accordance with standard Q 6.3.

Fan graph

The graph shows the total increase in pressure as a function of the gas-flow at certain fan rotation speeds, and the power requirements and operating curves providing the best working range. The fan graph applies to air with a density of 1.2 kg/m³. With belt drive, the power requirements Pe are increased by 10% to compensate for loss in transmission.

Performance examples for MC-TP-BP-PP and HCTP

Performance required q = 1.0 m³/s Pt = 1600 Pa. From the graph, it can be seen that the fan rotation speed obtainable is approximately n = 2650 rpm and in the top graph the net power requirement obtainable (excluding transmission loss) is P = 2.5 kW (n = 2650 rpm is within the recommended rotation speed range).

MCBP 028

Material 1 < 2800 rpm
Material 0, 2, 3, 4 < 1700 rpm

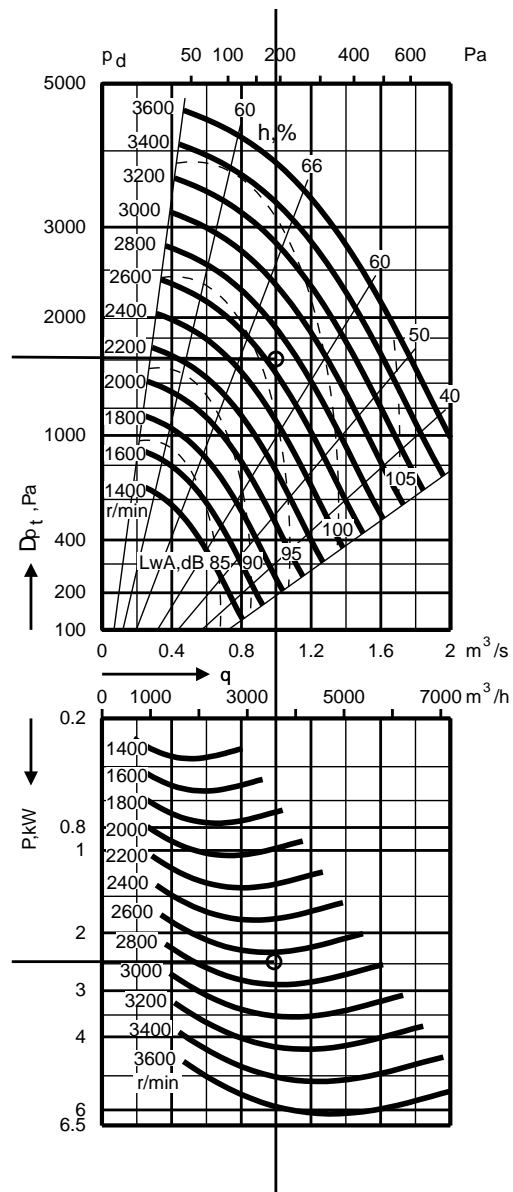

Mid frequency, Hz 63 125 250 500 1k 2k 4k 8k
Kok, outlet duct, dB 1 -2 7 -10 -7 -17 -21 -26
Kok, inlet duct, dB 8 2 2 -7 -3 -13 -14 -16

MCBP/MCTP/MCPP

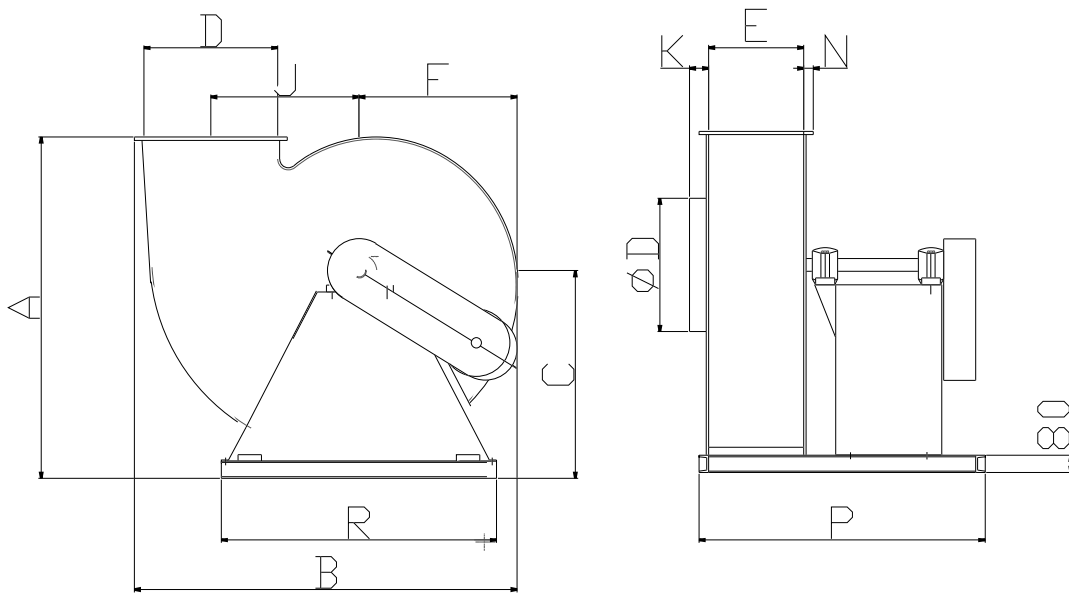

MCTP MCBP MCPP	A mm	B mm	C mm	ØD mm	E mm	F mm	J mm	K mm	R mm	P mm	N mm	kg
025	810	790	450	250	180	325	300	60	570	745	40	90
028	845	885	530	280	200	360	335	65	630	890	45	125
031	935	980	580	315	225	405	383	65	710	920	45	155
035	1040	1110	560	350	250	455	432	65	800	1050	45	270
040	1160	1235	630	400	280	510	480	70	900	1090	45	320
050	1290	1450	710	500	355	600	560	80	1040	1220	45	395
056	1440	1620	880	560	400	665	630	85	1140	1260	45	475
063	1610	1810	980	630	450	745	700	90	1300	1350	45	685
071	1800	2020	1080	710	500	835	785	95	1500	1565	45	795
080	2000	2240	1200	800	560	930	865	100	1700	1720	50	955
090	2230	2530	1330	900	630	1040	970	110	1900	1925	50	1135

MCPP



with true backward-inclined blades

Description

Applications

Medium-pressure radial fan designed for the conveyance of air or gas-flow which is corrosive, dust-polluted or explosive.

General specifications

- MCPP is fitted with a circular inlet and rectangular outlet connectors. Manufactured in PVC, PP, GRP and PPS-EL
- fitted with true backward-inclined blades
- P impeller
- operates within a range of flow of up to 17 m³/s and range of pressure of up to approximately 3500 Pa
- suitable for indoor and outdoor installation
- manufactured in eleven different sizes
- can be supplied with direct drive up to size 031 or belt drive; alternatively, fitted with a two-speed motor
- stand made of steel with painted surface finish in accordance with VV-AMA 83, environmental standard M3.

Standard sizes

MCPP fans are manufactured in eleven different sizes: 025, 028, 031, 035, 040, 050, 056, 063, 071, 080 and 090. The designations refer to the inlet dimensions in centimetres.

Belt drive assembly

Two types of belt drive are available:

- with steel bar base plate with the motor mounted on the angled side of stand (engine weight max. 70 kg).
- with steel bar base plate with fan and motor mounted side-by-side.

Program text

Radial fan, Arex model MCPP, with fan impeller with backward-inclined blades and shroud plate. Impeller and casing shall be manufactured in PVC, GRP, PP or PPS-EL (i.e. electro-conductive, self-extinguishing polypropylene).

Outlet position

The illustrations below show the fans from the drive side.

RD stands for right and LG for left-handed layout.

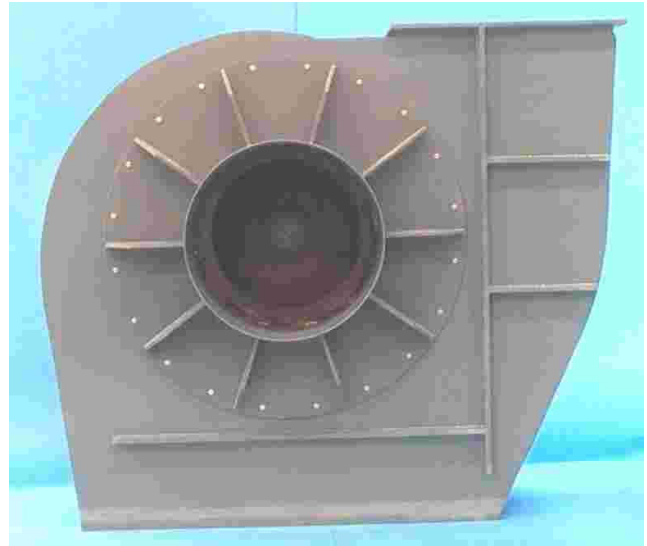
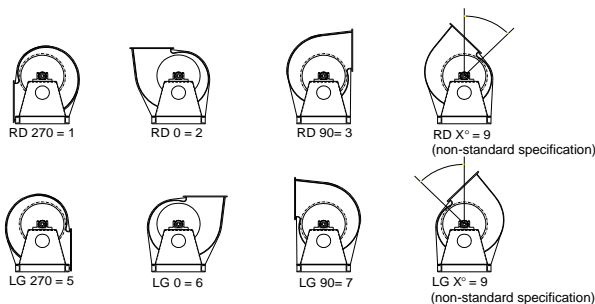

Specifications

MCPP		-XXX-XX-X-X-X
Sizes	025, 028, 031, 040, 050, 056, 063, 071, 080, 090	
Drive type	10= Belt drive, motor on side of stand 11= Belt drive, motor on base plate 40= Direct drive 1400 rpm 60= 900 rpm 80= 700 rpm 46= 1400/900 rpm 48= 1400/700 rpm	
Outlet position	1, 2, 3, 5, 6, 7, 9 See illustration below	
Materials, casing	0=PVC, 1=GRP, 2=PP 3=Various materials, 4=PPS-EL	
Materials, impeller	See materials, casing	

MCPP 025

Mtrl 1 < 3200 r/m
 Mtrl 0,2,3,4 < 1900 r/m

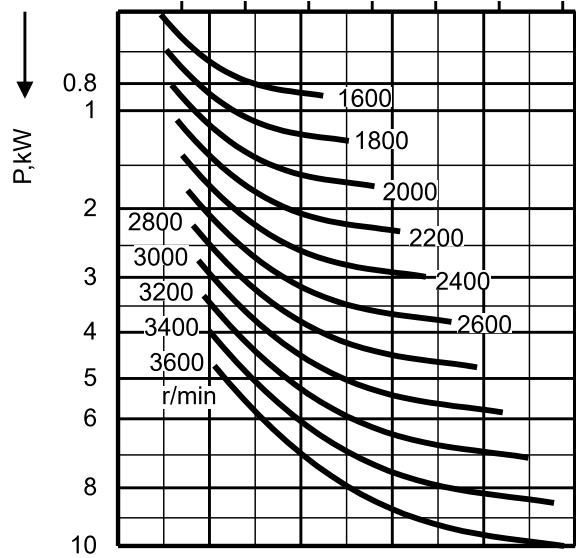
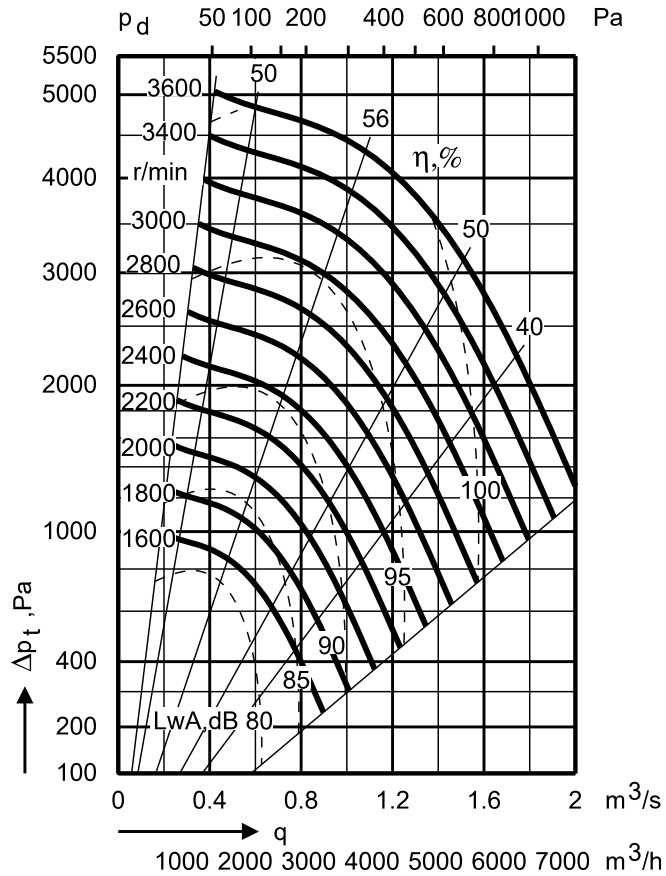

Mittfrekvens, Hz	63	125	250	500	1k	2k	4k	8k
Kok, utloppskanal, dB	6	-7	5	-4	-8	-18	-22	-25
Kok, inloppskanal, dB	8	7	3	-6	-5	-16	-17	-20

MCP P 028

Mtrl 1 < 2850 r/m

Mtrl 0,2,3,4 < 1700 r/m

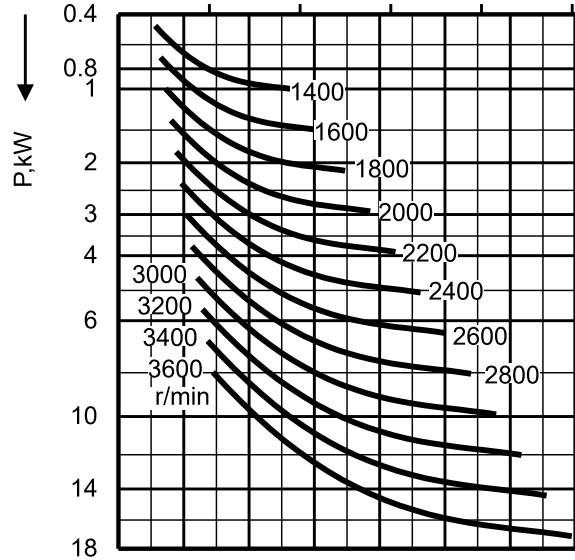
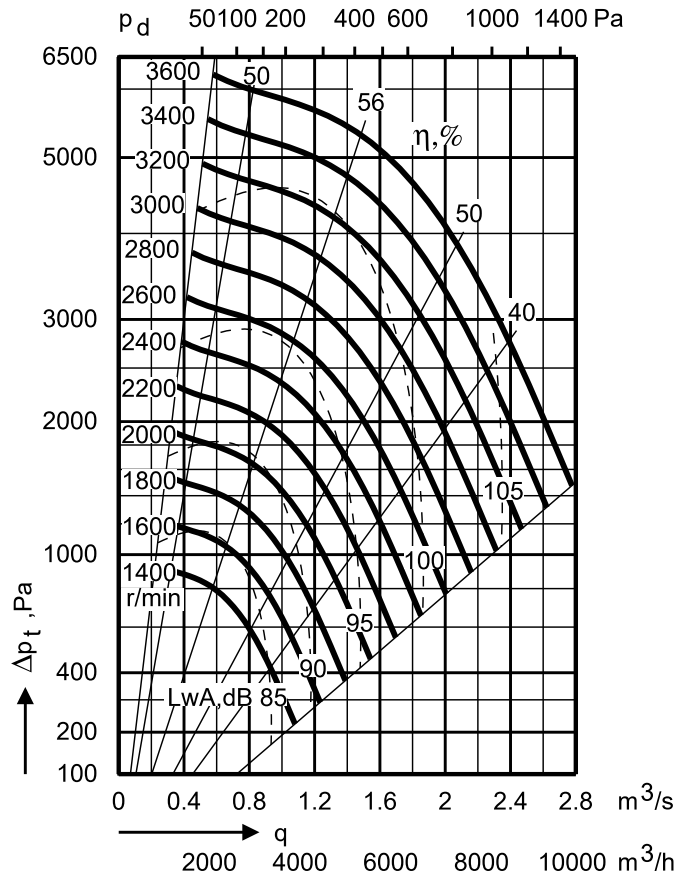

Mittfrekvens, Hz	63	125	250	500	1k	2k	4k	8k
Kok, utloppskanal, dB	6	-7	5	-4	-8	-18	-22	-25
Kok, inloppskanal, dB	8	7	3	-6	-5	-16	-17	-20

MCPP 031

Mtrl 1 < 2550 r/m
 Mtrl 0,2,3,4 < 1500 r/m

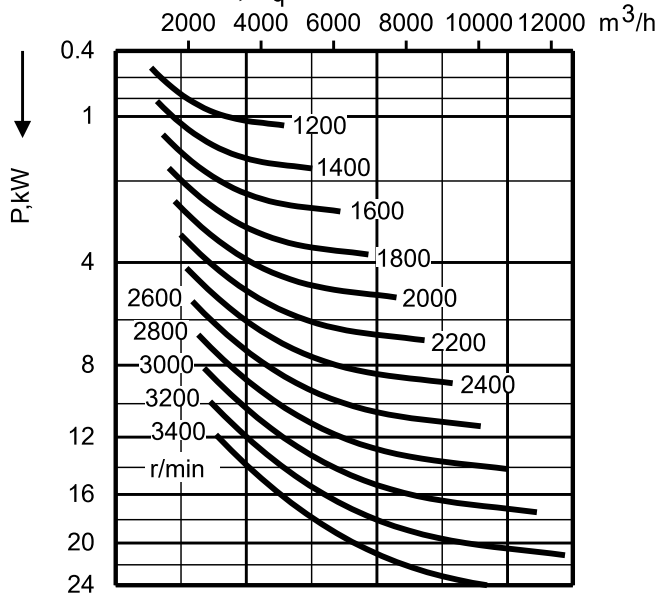
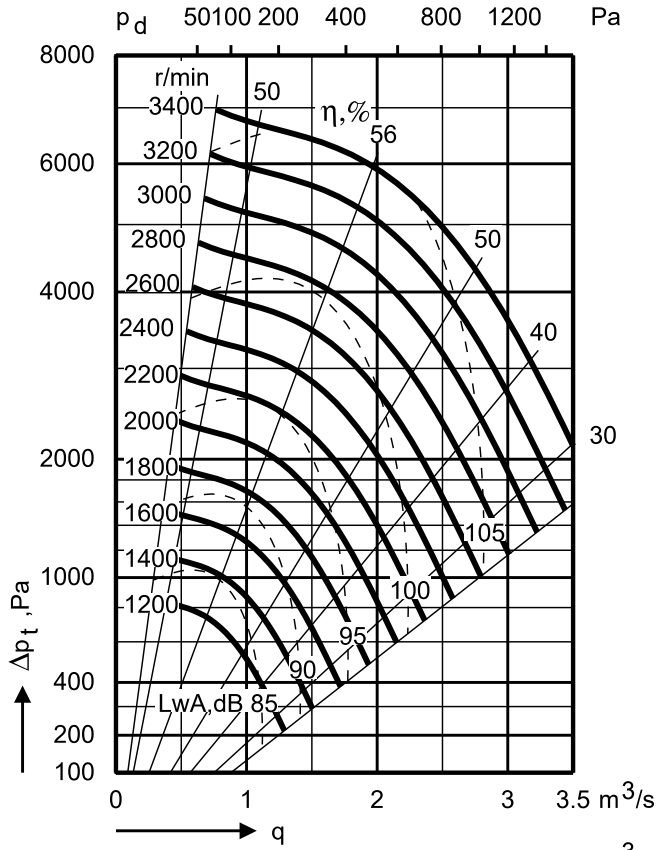

Mittfrekvens, Hz	63	125	250	500	1k	2k	4k	8k
Kok, utloppskanal, dB	6	-7	5	-4	-8	-18	-22	-25
Kok, inloppskanal, dB	8	7	3	-6	-5	-16	-17	-20



MCPP 035

Mtrl 1 < 2300 r/m
 Mtrl 0,2,3,4 < 1350 r/m

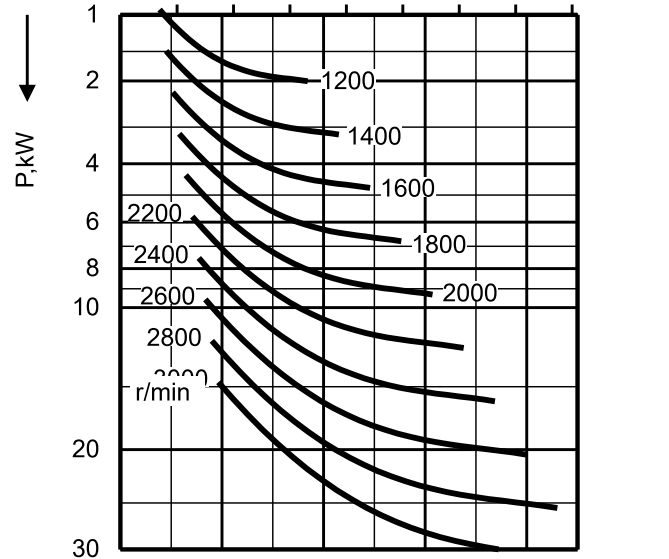
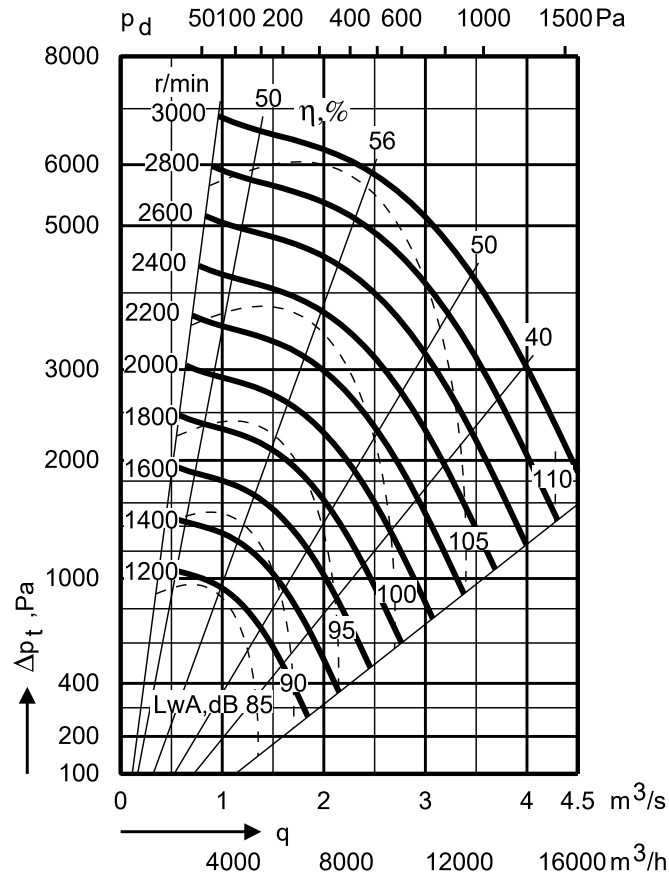

Mittfrekvens, Hz	63	125	250	500	1k	2k	4k	8k
Kok, utloppskanal, dB	6	-7	5	-4	-8	-18	-22	-25
Kok, inloppskanal, dB	8	7	3	-6	-5	-16	-17	-20

MCPPP 040

Mtrl 1 < 2000 r/m
 Mtrl 0,2,3,4 < 1200 r/m

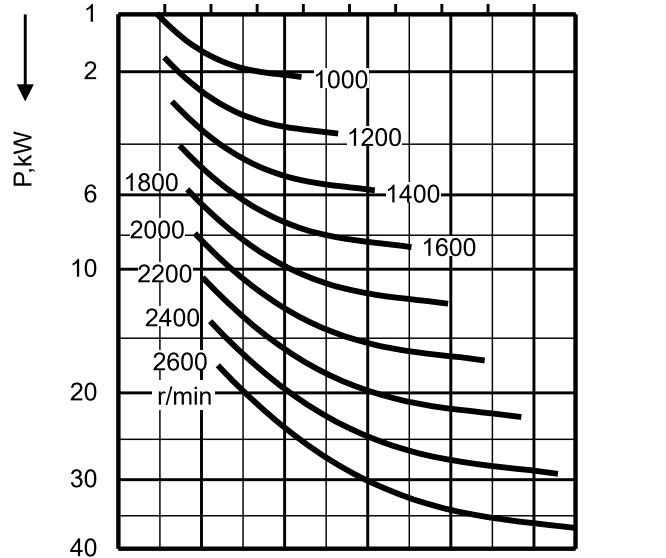
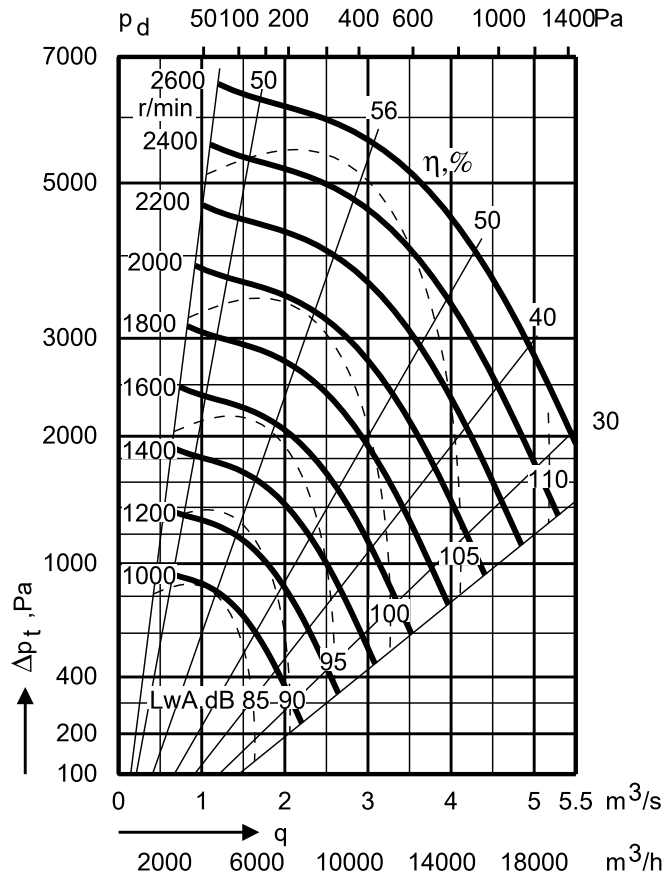

Mittfrekvens, Hz	63	125	250	500	1k	2k	4k	8k
Kok, utloppskanal, dB	6	-7	5	-4	-8	-18	-22	-25
Kok, inloppskanal, dB	8	7	3	-6	-5	-16	-17	-20

MCPP 050

Mtrl 1 < 1650 r/min
 Mtrl 0,2,3,4 < 1000 r/min

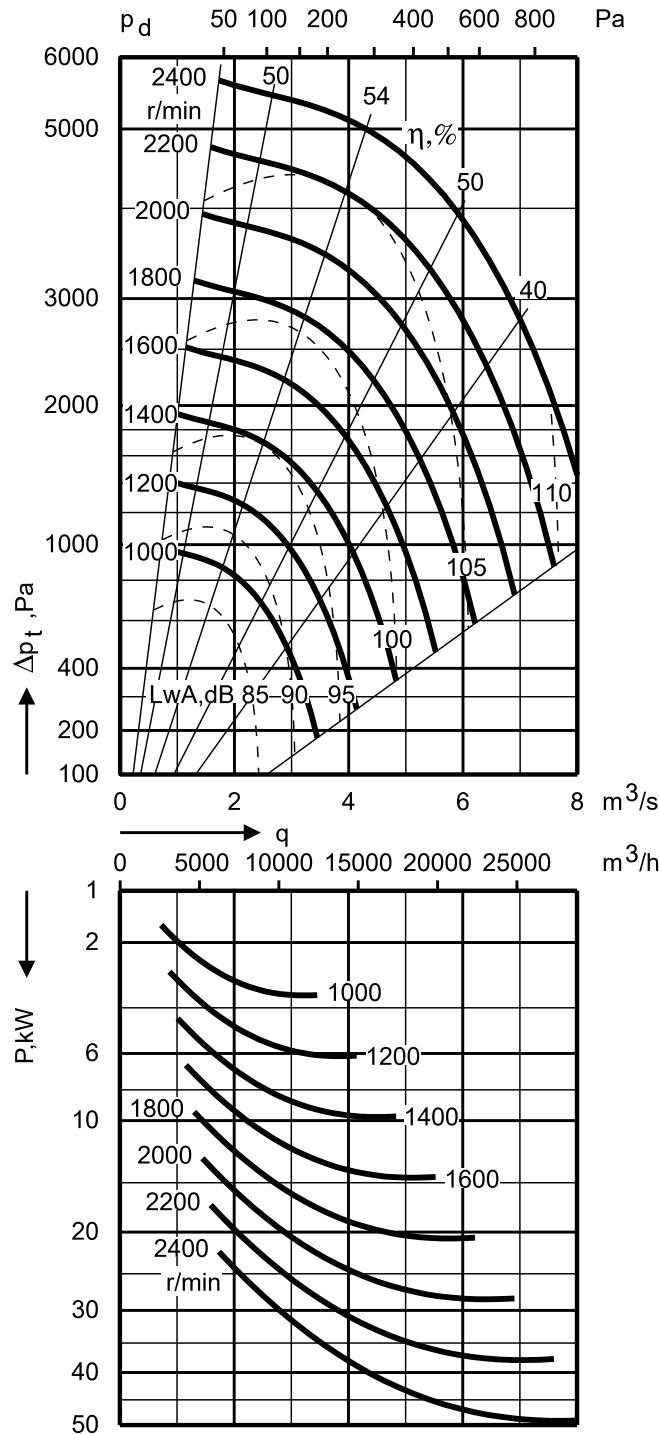

Mittfrekvens, Hz	63	125	250	500	1k	2k	4k	8k
Kok, utloppskanal, dB	6	-7	5	-4	-8	-18	-22	-25
Kok, inloppskanal, dB	8	7	3	-6	-5	-16	-17	-20

MCPP 056

Mtrl 1 < 1525 r/m
 Mtrl 0,2,3,4 < 900 r/m

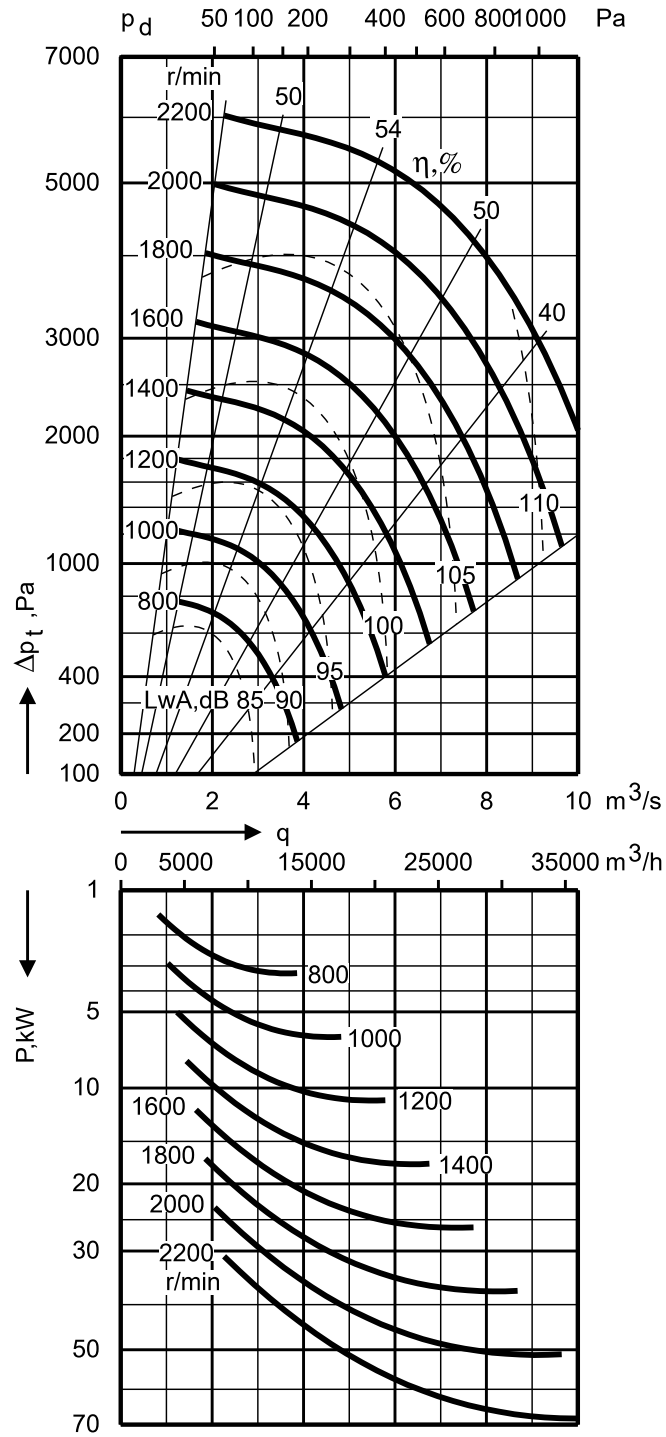

Mittfrekvens, Hz	63	125	250	500	1k	2k	4k	8k
Kok, utloppskanal, dB	6	-7	5	-4	-8	-18	-22	-25
Kok, inloppskanal, dB	8	7	3	-6	-5	-16	-17	-20

MCPP 063

Mtrl 1 < 1400 r/m
 Mtrl 0,2,3,4 < 850 r/m

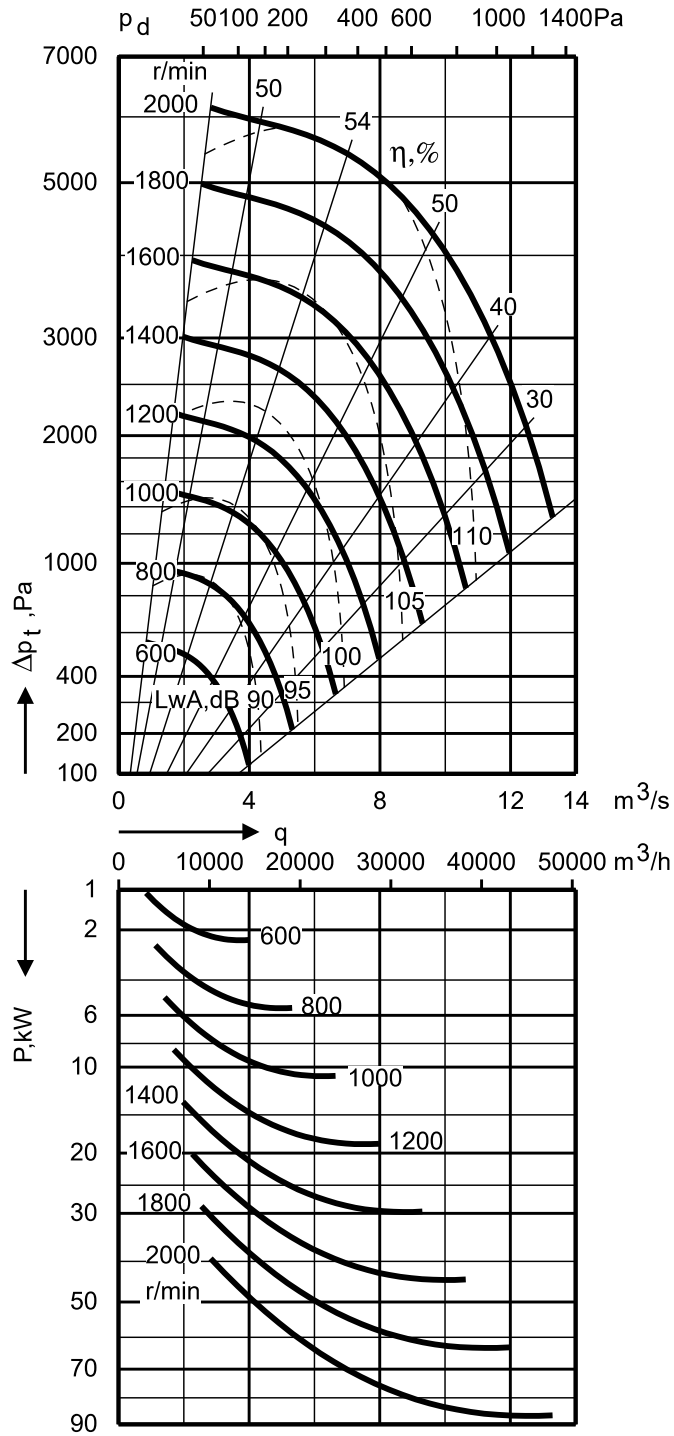

Mittfrekvens, Hz	63	125	250	500	1k	2k	4k	8k
Kok, utloppskanal, dB	-3	6	3	3	-6	-13	-18	-23
Kok, inloppskanal, dB	8	6	1	0	-5	-9	-13	-19

MCPP 071

Mtrl 1 < 1250 r/m
 Mtrl 0,2,3,4 < 750 r/m

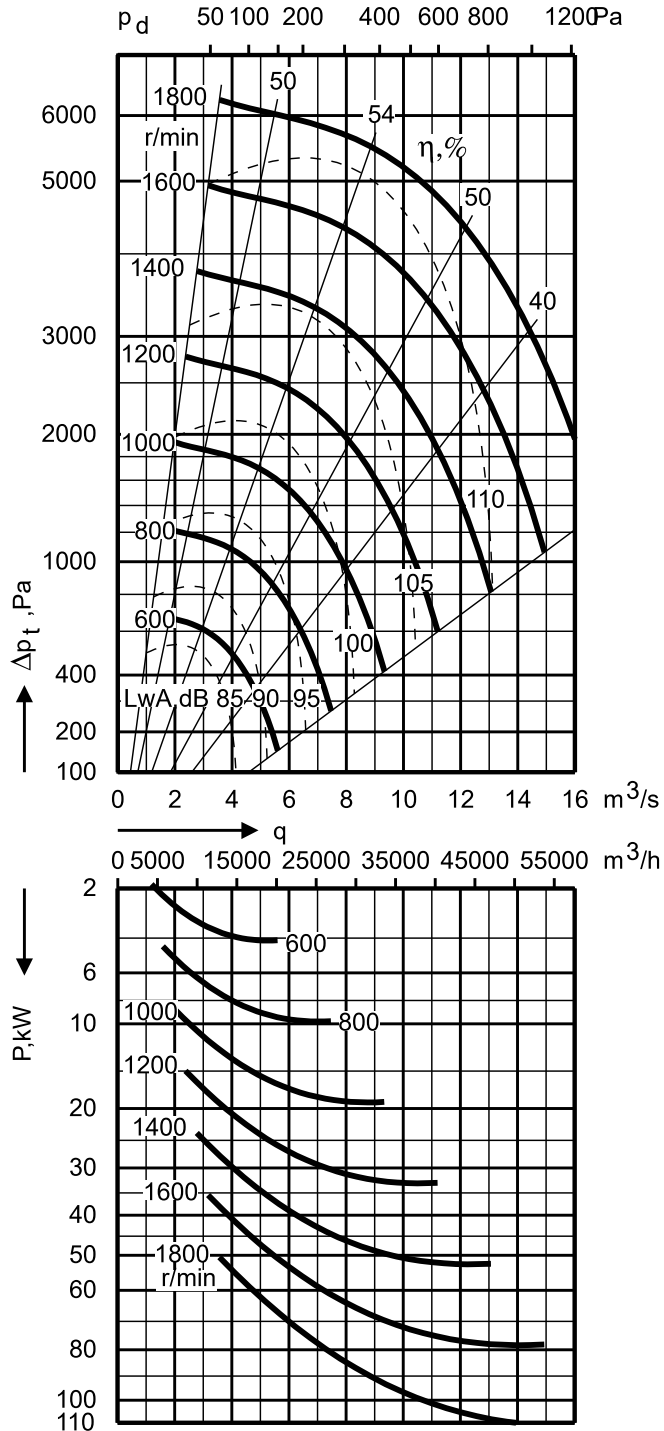

Mittfrekvens, Hz	63	125	250	500	1k	2k	4k	8k
Kok, utloppskanal, dB	6	-7	5	-4	-8	-18	-22	-25
Kok, inloppskanal, dB	8	7	3	-6	-5	-16	-17	-20



MCPP 080

Mtrl 1 < 1150 r/m
 Mtrl 0,2,3,4 < 675 r/m

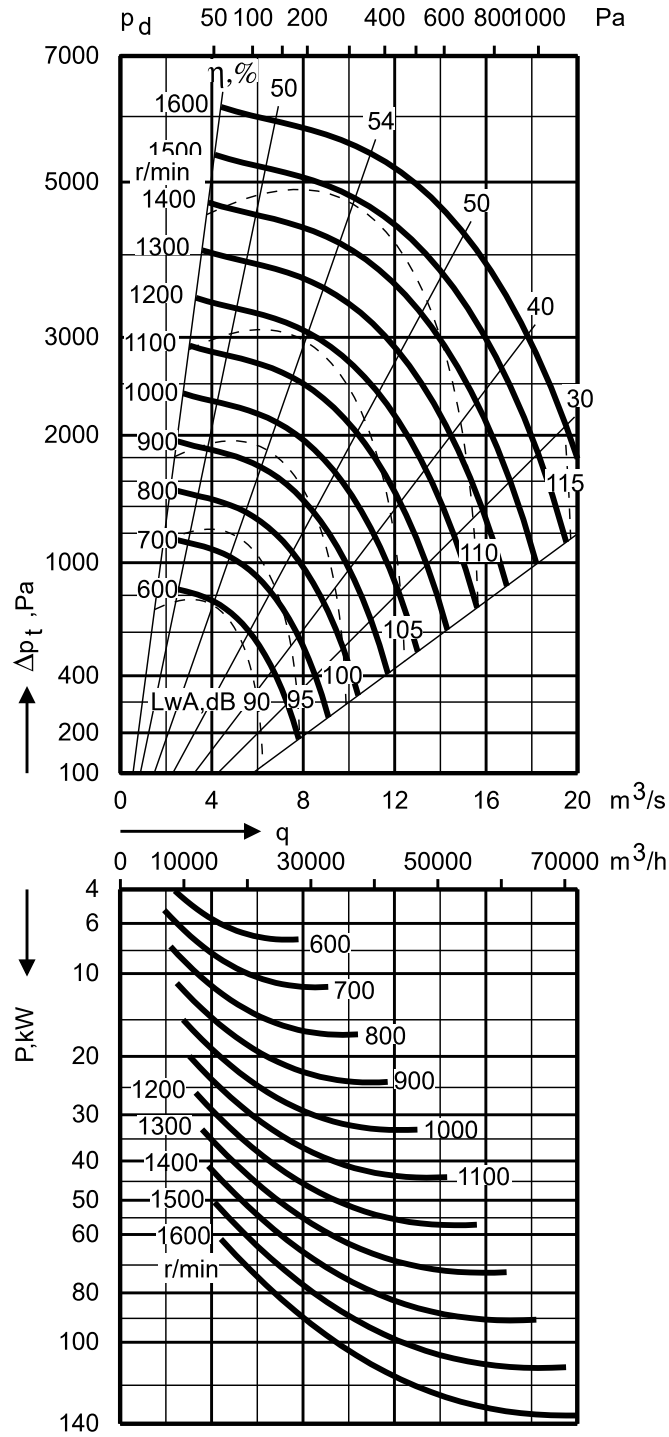

Mittfrekvens, Hz	63	125	250	500	1k	2k	4k	8k
Kok, utloppskanal, dB	6	-7	5	-4	-8	-18	-22	-25
Kok, inloppskanal, dB	8	7	3	-6	-5	-16	-17	-20

MCPP 090

Mtrl 1 < 1025 r/m

Mtrl 0,2,3,4 < 625 r/m

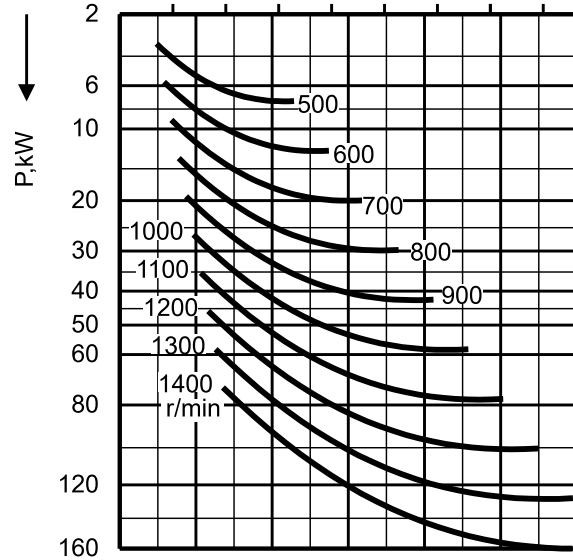
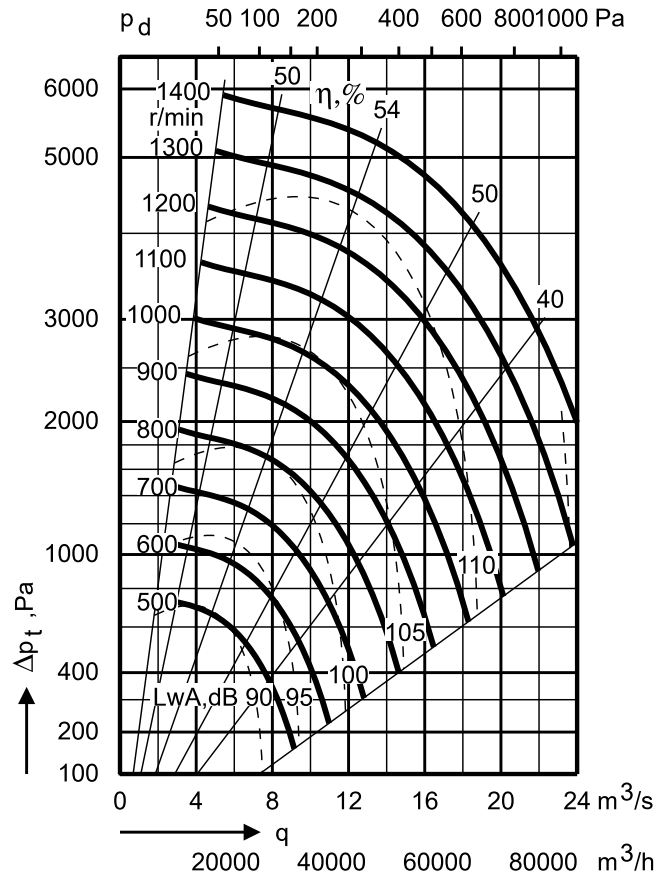

Mittfrekvens, Hz	63	125	250	500	1k	2k	4k	8k
Kok, utloppskanal, dB	6	-7	5	-4	-8	-18	-22	-25
Kok, inloppskanal, dB	8	7	3	-6	-5	-16	-17	-20

MCPP

Accessories

A wide range of accessories are available for MCPP fans, as shown in the exploded diagrams and specifications below.

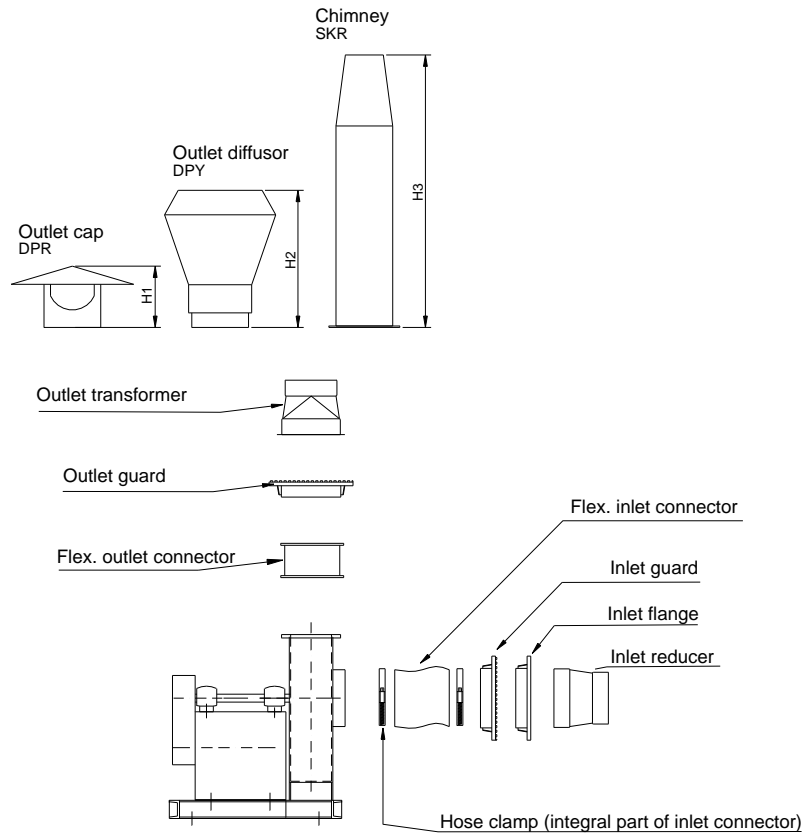

Specifications

- Drive Motor, according to fan capacity
- PVC weather protection for motor
- Anti-vibration mountings
- Complementary belt drive with belts, pulleys, bushing and belt guard
- Other Drainage stud at lowest point
- Splinter protector
- Inspection door

MCPP	DPR	DPY	SKR (Requires bracing)
	H1	H2	H3
020	140	435	600
025	160	505	800
028	175	585	800
031	210	650	1000
035	200	695	1000
040	210	650	2000
050	265	740	2200
056	297	925	2500
063	330	925	2500
071	370	1110	2500
080	-	-	3000
090	-	-	4000

In an order or program text, a complete fan specification might read as follows:

1 radial fan MCPP 056-10-2-0-1. Motor 3.0/0.6 kW 1445/975 rpm, 400 V, 50 Hz, 3-phase. Belt drive rotation speed 1200 rpm. Inlet connector. Outlet transformer. Outlet diffuser DPY. All inlet and outlet components made of PVC.

Note. Accessories manufactured in same material as fan casing.



INSTALLATION AND MAINTENANCE

Plastic centrifugal fans

<i>List of content</i>	<i>Page</i>
1. GENERAL.....	2
1.1 TRANSPORT AND LIFTING.....	2
1.2 DELIVERY CHECK	2
1.3 STORAGE BEFORE INSTALLATION	2
2. INSTALLATION.....	2
2.1 FITTING AND SECURING THE FAN	2
2.2 CONNECTION OF DUCTING.....	2
2.3 GUARDS.....	3
2.4 ELECTRIC INSTALLATION	3
3. TESTING.....	3
4. FAN OPERATION.....	4
5. MAINTENANCE	4
5.1 GENERAL INSPECTION	4
5.2 MOTOR.....	5
5.3 BELT DRIVE (if applicable)	5
5.4 BEARINGS (if applicable).....	5
6. DISMANTLING THE IMPELLER	5

AB AREX

Postal address
Box 173
S-615 24 VALDEMARSVIK
SWEDEN

Visiting Address
Vammar Industriområde
VALDEMARSVIK
SWEDEN

Telephone
Int.: + 46 123 299 90
E-mail
mail@arex.se

Fax
Int.: + 46 123 513 18
Website
www.arex.se
Inst.& maint. centrifugal fans



INSTALLATION AND MAINTENANCE

1. GENERAL

The radial fans are either direct or belt driven to suit the intended application. The impeller is statically and dynamically balanced.

WARNING! Do not start working on the fan unless the power switch or the lockable main power switch has been switched in the OFF position.

1.1 TRANSPORT AND LIFTING

All handling should be carried out carefully.

Do not fix lifting equipment to plastic components or fan shaft. Lifting equipment should be affixed to a frame or steel foundation.

1.2 DELIVERY CHECK

Check carefully for signs of transport damage and make sure that the impeller rotates easily. In the event of damage to the equipment **make an immediate report to the carriers concerned**. Failure to report damage will result in the invalidity of the transportation insurance.

1.3 STORAGE BEFORE INSTALLATION

The fan shall be storage in a dry and heated up area, to avoid any risk of getting condensates inside the electric motor that could cause corrosion as a result.

2. INSTALLATION

2.1 FITTING AND SECURING THE FAN

The fan should be bolted (with or without the anti-vibration mountings) to a stable flat surface.

2.2 CONNECTION OF DUCTING

The fan casing should not support the weight of any ducting connected to the fan. Flexible duct sleeves should be used as ducting joints.

AB AREX

Postal address
Box 173
S-615 24 VALDEMARSVIK
SWEDEN

Visiting Address
Vammar Industriområde
VALDEMARSVIK
SWEDEN

Telephone
Int.: + 46 123 299 90
E-mail
mail@arex.se

Fax
Int.: + 46 123 513 18
Website
www.arex.se
Inst. & maint. centrifugal fans



INSTALLATION AND MAINTENANCE

2.3 GUARDS

Industrial safety legislation in most countries specifies that rotating machine components must be provided with reliable guards.

Such instructions must be observed when installing the fan. **If the inlet or outlet of the fan is open it must be provided with a protective grill, which is available as an accessory.**

2.4 ELECTRIC INSTALLATION

(To be carried out by an authorised electrician)

After connecting the fan motor, check that the impeller rotates in the direction shown by the arrow on the end wall of the casing.

The fan should be equipped with a safety-isolating switch (not included in the fan delivery). Before work is started on the fan, the safety-isolating switch must always be in position OFF.

3. TESTING

Before testing the fan check that:

1. The fan and motor have been correctly aligned and bolted down.
2. The belt or belts have been correctly tensioned, where applicable see point 5.3.
3. The bearings have been lubricated, where applicable see point 5.4
4. The anti-vibration mountings have been correctly fitted.
5. The flexible duct joints are tight and the fan casing does not support the weight of ducts.
6. Guards have been fitted and are well secured.
7. No tools or other foreign objects have been left in the casing or ducts.

Start the fan and check that:

1. The fan rotates in the correct direction.
2. There are no abnormal vibrations or noise.
3. The bearing temperatures are normal, where applicable see point 5.4.
4. The belt tension is correct after 24 hours operation, adjust if necessary.

When starting the fan after installing a new or renovated an existing bearing the bearing temperature may rise to a level which is 10-15°C higher then when the fan runs steadily. This condition is normal due to the fact that the bearing has been lubricated. The temperature will return to normal on steady fan operation after about 24 hours running time depending on the amount of grease that are filled in the bearing housing. (An excessive amount of grease is a common cause of high temperature). The above condition may also occur after periodically lubricating the bearing. The temperature generally increases as described above but will generally stabilise after the fan has run for 24 hours.

AB AREX

Postal address
Box 173
S-615 24 VALDEMARSVIK
SWEDEN

Visiting Address
Vammar Industriområde
VALDEMARSVIK
SWEDEN

Telephone
Int.: + 46 123 299 90
E-mail
mail@arex.se

Fax
Int.: + 46 123 513 18
Website
www.arex.se
Inst. & maint. centrifugal fans



INSTALLATION AND MAINTENANCE

4. FAN OPERATION

The fan should not be exposed to impact or shocks. Make sure no particles adhere to impeller as this can result in imbalance and a breakdown. If particles can be drawn into the fan inlet must be fitted with a grille, which is available as an accessory. The transported air's temperature must not exceed the values stated below:

Fan material	Maximum temp. °C
PVC	+55 °C
PP	+60 °C
PEH	+70 °C
GRP	+90 °C

(GRP quality withstanding higher temperatures can be supplied on request)

5. MAINTENANCE

5.1 GENERAL INSPECTION

Rotating machine components such as: bearings, motors and belt assemble are subjects to wear. Increased temperatures, high degrees of contamination and high speed increase the level of wear. In some installations ducts, which results in erosion damage to the impeller and fan casing, can occur. In other installations the dust can form a layer of grime on the impeller and fan casing. Layers of grime reduce the fan's output and give rise to imbalance resulting in breakdown.

After 1000 hours running time or when necessary:

1. Check that the impeller rotates easily and that it does not come into contact with the casing.
2. Check that fan does not vibrate or is noisy.
3. Check that the bearing temperature is normal. Noise from bearing can be an indication that lubrication is required.
4. Check all belts and their tension.
5. If necessary clean the fan casing and impeller.

Twice a year or when necessary:

1. Lubricate the bearings
2. Check that the impeller is undamaged and sits securely.
3. Check that the motor's fixture is in good condition and that bolts are tightened.
4. Clean all dirt, dust and oil from motor.

AB AREX

Postal address
Box 173
S-615 24 VALDEMARSVIK
SWEDEN

Visiting Address
Vammar Industriområde
VALDEMARSVIK
SWEDEN

Telephone
Int.: + 46 123 299 90
E-mail
mail@arex.se

Fax
Int.: + 46 123 513 18
Website
www.arex.se
Inst. & maint. centrifugal fans



INSTALLATION AND MAINTENANCE

5.2 MOTOR

Follow the manufacturer's instruction regarding lubrication and maintenance.

5.3 BELT DRIVE (if applicable)

Control the belt tension by pressing down the free belt length using the force F. The correct belt tension while applying pressure is equal to 1-1.5% of free belt length. The force F is defined in the table below.

Minimum pulley dia.	F (Newton) Minimum	F (Newton) Maximum
63 – 89	11	16
90 – 114	12	18
115 – 152	13	20

5.4 BEARINGS (if applicable)

Fans driven by V-belts are fitted with two bearings, which are lubricated using grease. The bearings should at least be lubricated 2 times/year, see appendix 1. Increased temperature conditions as well as other loads reduce the time interval between lubrication. Every increase of 15 °C over the 70 °C bearing temperature results in halving of the lubrication interval. The maximum permitted temperature of the grease must not be exceeded. The bearing housing is not usually fitted with a grease nipple. Grease is applied by removing the inner section of the bearing. All old grease should be removed before apply the new grease. The bearing housing should not be fitted completely with grease. Too much grease can cause extreme increase in temperature. After lubrication make sure the bearing runs easily without noise.

6. DISMANTLING THE IMPELLER

1. Remove the rear plate from the fan casing. (If the case is not fitted with a rear plate remove the inlet plate)
2. Dismantle the fan housing.
3. If belt driven, remove the bearing's clamping sleeve from the shaft.
4. Pull out the impeller and shaft.
5. Pull of the impeller from the shaft.

To assemble follow the above instructions in the reverse order.

AB AREX

Postal address
Box 173
S-615 24 VALDEMARSVIK
SWEDEN

Visiting Address
Vammar Industriområde
VALDEMARSVIK
SWEDEN

Telephone
Int.: + 46 123 299 90
E-mail
mail@arex.se

Fax
Int.: + 46 123 513 18
Website
www.arex.se
Inst. & maint. centrifugal fans



EG-Försäkran om överensstämmelse



TILLVERKARE:

**AB AREX
Box 173
615 24 VALDEMARSVIK**

MASKIN:

**Radialfläktar med beteckningar:
LCPA MCBP HCTP
LCPB MCPP
LCPR MCTP
LCPS**

FÖRSÄKRAN:

**Försäkrar under eget ansvar att angiven maskin
är tillverkad enligt följande direktiv och standarder.
Maskindirektivet 98/37/EEG
Lågspänningsdirektivet 73/23/EEG inkl. tillägg
EMC-direktivet 89/336/EEG inkl. tillägg**

ÅBEROPAD STANDARD:

**SS EN 60 034-1
SS EN 292-1-2
SS EN 294**

FÖRBEHÅLL:

**Denna försäkran gäller under förutsättning att fläkten
installeras enl. våra anvisningar.
Se installation och skötselanvisningar.**

**Valdemarsvik 2003
AB AREX**

A handwritten signature in blue ink, appearing to be "M. M. M." followed by a horizontal line.